



M
MAK
MAKINA

LAMALAR



ASKILI SİSTEM LAMALAR (1600-1699)

30x10 mm LAMA - PİRİNÇ

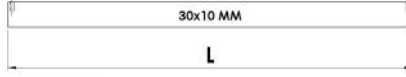

KULLANIM ALANI: ASKILI SİSTEM KABINLER İÇİN

L	YÜZEY KAPLAMA	ÜRÜN KODU
1000 MM	KROM	MAK1600
	SİYAH	
	PVD SARI	
	PVD BRONZ PVD BAKIR	
1500 MM	KROM	MAK1601
	SİYAH	
	PVD SARI	
	PVD BRONZ PVD BAKIR	
2000 MM	KROM	MAK1602
	SİYAH	
	PVD SARI	
	PVD BRONZ PVD BAKIR	

30x10 mm PROFİL - PİRİNÇ

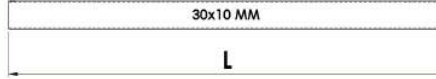

KULLANIM ALANI: ASKILI SİSTEM KABINLER İÇİN

L	YÜZEY KAPLAMA	ÜRÜN KODU
1000 MM	KROM	MAK1603
	SİYAH	
	PVD SARI	
	PVD BRONZ PVD BAKIR	
1500 MM	KROM	MAK1604
	SİYAH	
	PVD SARI	
	PVD BRONZ PVD BAKIR	
2000 MM	KROM	MAK1605
	SİYAH	
	PVD SARI	
	PVD BRONZ PVD BAKIR	



ASKILI SİSTEM LAMALAR (1600-1699)

30x10 mm PROFİL - PASLANMAZ

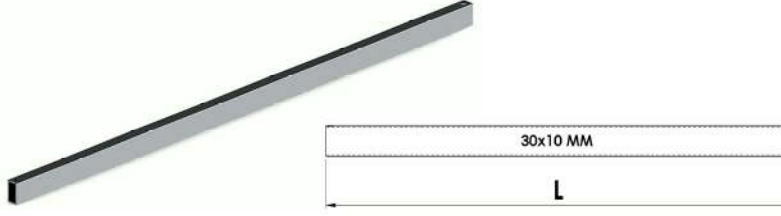

KULLANIM ALANI: ASKILI SİSTEM KABİNLER İÇİN

L	YÜZEY KAPLAMA	ÜRÜN KODU
2000 MM	KROM	MAK1606
	SİYAH	
	PVD SARI	
	PVD BRONZ	
	PVD BAKIR	
1500 MM	KROM	MAK1617
	SİYAH	
	PVD SARI	
	PVD BRONZ	
	PVD BAKIR	

40x10 mm LAMA - PİRİNÇ

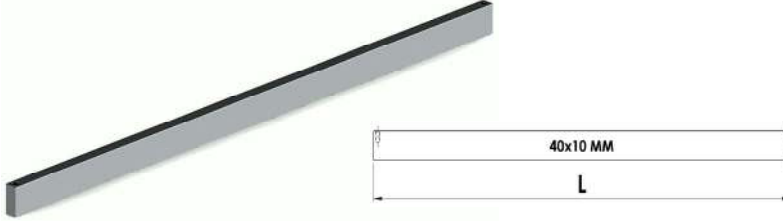

KULLANIM ALANI: ASKILI SİSTEM KABİNLER İÇİN

L	YÜZEY KAPLAMA	ÜRÜN KODU
1000 MM	KROM	MAK1607
	SİYAH	
	PVD SARI	
	PVD BRONZ	
	PVD BAKIR	
1500 MM	KROM	MAK1608
	SİYAH	
	PVD SARI	
	PVD BRONZ	
	PVD BAKIR	
2000 MM	KROM	MAK1609
	SİYAH	
	PVD SARI	
	PVD BRONZ	
	PVD BAKIR	



ASKILI SİSTEM LAMALAR (1600-1699)

40x10 mm PROFİL - PASLANMAZ

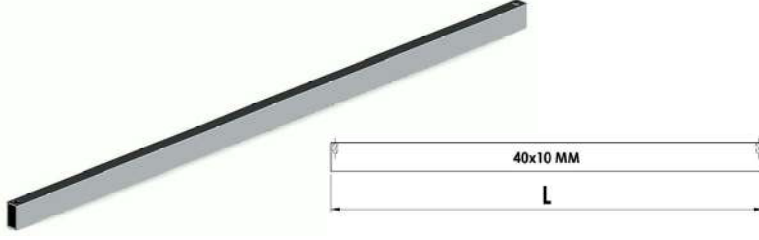

KULLANIM ALANI: ASKILI SİSTEM KABINLER İÇİN

L	YÜZEY KAPLAMA	ÜRÜN KODU
1500 MM	KROM	MAK1620
	SİYAH	
	PVD SARI	
	PVD BRONZ PVD BAKIR	
2000 MM	KROM	MAK1621
	SİYAH	
	PVD SARI	
	PVD BRONZ PVD BAKIR	

Ø22 mm BORU PROFİL - PASLANMAZ

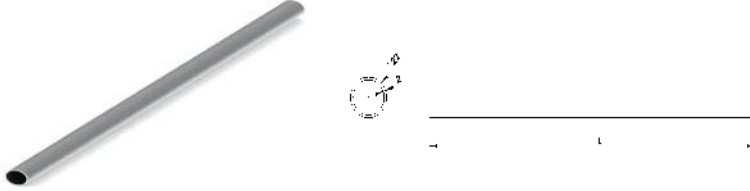

KULLANIM ALANI: BORU SİSTEM KABINLER İÇİN

L	YÜZEY KAPLAMA	ÜRÜN KODU
2000 MM	KROM	MAK1618
	SİYAH	
	PVD SARI	
	PVD BRONZ PVD BAKIR	
1500 MM	KROM	MAK1619
	SİYAH	
	PVD SARI	
	PVD BRONZ PVD BAKIR	



ASKILI SİSTEM LAMALAR (1600-1699)

Ø22 mm PASLANMAZ- ÇUBUK

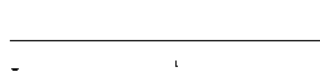

KULLANIM ALANI: BORU SİSTEM KABİNLER İÇİN

L	YÜZEY KAPLAMA	ÜRÜN KODU
1000 MM	KROM	MAK1622
	SİYAH	
	PVD SARI	
	PVD BRONZ PVD BAKIR	
1500 MM	KROM	MAK1623
	SİYAH	
	PVD SARI	
	PVD BRONZ PVD BAKIR	
2000 MM	KROM	MAK1624
	SİYAH	
	PVD SARI	
	PVD BRONZ PVD BAKIR	

★ YENİ 20x10 mm PROFİL - PASLANMAZ

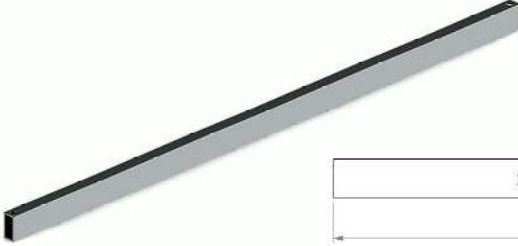



KULLANIM ALANI: ASKILI SİSTEM KABİNLER İÇİN

L	YÜZEY KAPLAMA	ÜRÜN KODU
2000 MM	KROM	MAK1625
	SİYAH	
	PVD SARI	
	PVD BRONZ PVD BAKIR	
1500 MM	KROM	MAK1626
	SİYAH	
	PVD SARI	
	PVD BRONZ PVD BAKIR	

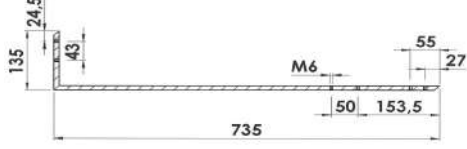

ASKILI SİSTEM LAMALAR (1600-1699)

L MENTEŞELİ LAMA			
  KULLANIM ALANI: PİVOT SİSTEM YANPANELLİ MALZEME: PİRİNÇ	60 CM ÇALIŞIR CAMA GÖRE	YÜZEY KAPLAMA	ÜRÜN KODU
		KROM	MAK1610 PRİNÇ
		SİYAH	
		PVD SARI	
		PVD BRONZ	
PVD BAKIR			

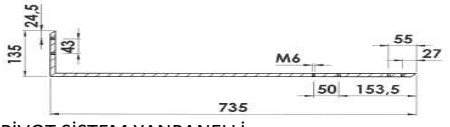
L MENTEŞELİ LAMA			
  KULLANIM ALANI: PİVOT SİSTEM YANPANELLİ MALZEME: ALÜMİNYUM	60 CM ÇALIŞIR CAMA GÖRE	YÜZEY KAPLAMA	ÜRÜN KODU
		KROM	MAK1610 ALÜMİNYUM
		SİYAH	
		PVD SARI	
		PVD BRONZ	
PVD BAKIR			

DÜZ MENTEŞELİ LAMA			
  KULLANIM ALANI: PİVOT SİSTEM İKİ DUVAR ARASI MALZEME: PİRİNÇ	60 CM ÇALIŞIR CAMA GÖRE	YÜZEY KAPLAMA	ÜRÜN KODU
		KROM	MAK1611 PRİNÇ
		SİYAH	
		PVD SARI	
		PVD BRONZ	
PVD BAKIR			



ASKILI SİSTEM LAMALAR (1600-1699)

DÜZ MENTEŞELİ LAMA			
  KULLANIM ALANI: PİVOT SİSTEM İKİ DUVAR ARASI MALZEME: ALÜMİNYUM	60 CM ÇALIŞIR CAMA GÖRE	YÜZEY KAPLAMA	ÜRÜN KODU
		KROM	MAK1611 ALÜMİNYUM
		SİYAH	
		PVD SARI	
		PVD BRONZ	
PVD BAKIR			

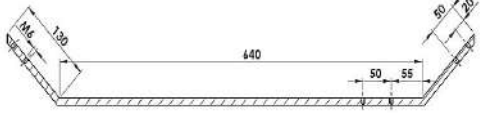
AÇILI MENTEŞELİ LAMA			
  KULLANIM ALANI: PİVOT SİSTEM KÖŞE MALZEME: PİRİNÇ	60 CM ÇALIŞIR CAMA GÖRE	YÜZEY KAPLAMA	ÜRÜN KODU
		KROM	MAK1612
		SİYAH	
		PVD SARI	
		PVD BRONZ	
PVD BAKIR			

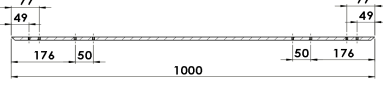
DÜZ MENTEŞELİ LAMA			
  KULLANIM ALANI: PİVOT SİSTEM 2 SABİT 2 ÇALIŞIR MALZEME: PİRİNÇ	DUVARDAN DUVARA 120 CM KABİNE GÖRE	YÜZEY KAPLAMA	ÜRÜN KODU
		KROM	MAK1613 PİRİNÇ
		SİYAH	
		PVD SARI	
		PVD BRONZ	
PVD BAKIR			

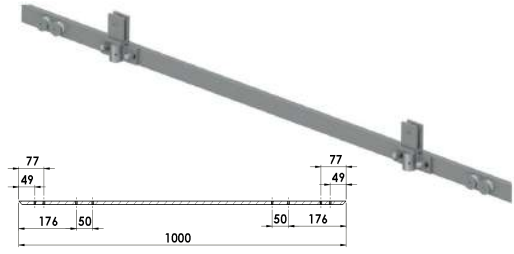

ASKILI SİSTEM LAMALAR (1600-1699)

DÜZ MENTEŞELİ LAMA			
 <p>KULLANIM ALANI: PİVOT SİSTEM 2 SABİT 2 ÇALIŞIR MALZEME: ALÜMİNYUM</p>	DUVARDAN DUVARA 120 CM KABİNE GÖRE	YÜZEY KAPLAMA	ÜRÜN KODU
		KROM	MAK1613 ALÜMİNYUM
		SİYAH	
		PVD SARI	
		PVD BRONZ	
PVD BAKIR			

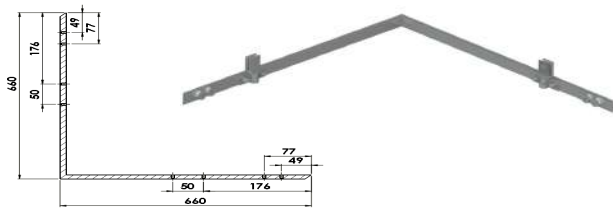
V MENTEŞELİ LAMA			
 <p>KULLANIM ALANI: PİVOT SİSTEM KÖŞE MALZEME: PİRİNÇ</p>	90x90 CM KABİNE GÖRE	YÜZEY KAPLAMA	ÜRÜN KODU
		KROM	MAK1614 PİRİNÇ
		SİYAH	
		PVD SARI	
		PVD BRONZ	
PVD BAKIR			

V MENTEŞELİ LAMA			
 <p>KULLANIM ALANI: PİVOT SİSTEM KÖŞE MALZEME: ALÜMİNYUM</p>	90x90 CM KABİNE GÖRE	YÜZEY KAPLAMA	ÜRÜN KODU
		KROM	MAK1614 ALÜMİNYUM
		SİYAH	
		PVD SARI	
		PVD BRONZ	
PVD BAKIR			



ASKILI SİSTEM LAMALAR (1600-1699)

OVAL (10x30) PROFİL			
 KULLANIM ALANI: ASKILI SİSTEM OVAL KABİN MALZEME: PİRİNÇ	90x90 CM KABİNE GÖRE	YÜZEY KAPLAMA	ÜRÜN KODU
		KROM	MAK1615
		SİYAH	
		PVD SARI	
		PVD BRONZ	
PVD BAKIR			

OVAL MENTEŞELİ LAMA			
 KULLANIM ALANI: MK08 PİVOT OVAL KABİN MALZEME: PİRİNÇ (30x10mm)	90x90 CM KABİNE GÖRE	YÜZEY KAPLAMA	ÜRÜN KODU
		KROM	MAK1616 PİRİNÇ
		SİYAH	
		PVD SARI	
		PVD BRONZ	
PVD BAKIR			

OVAL MENTEŞELİ LAMA			
 KULLANIM ALANI: MK08 PİVOT OVAL KABİN MALZEME: ALÜMİNYUM (30x10mm)	90x90 CM KABİNE GÖRE	YÜZEY KAPLAMA	ÜRÜN KODU
		KROM	MAK1616 ALÜMİNYUM
		SİYAH	
		PVD SARI	
		PVD BRONZ	
PVD BAKIR			

**MAK
MAKINA**

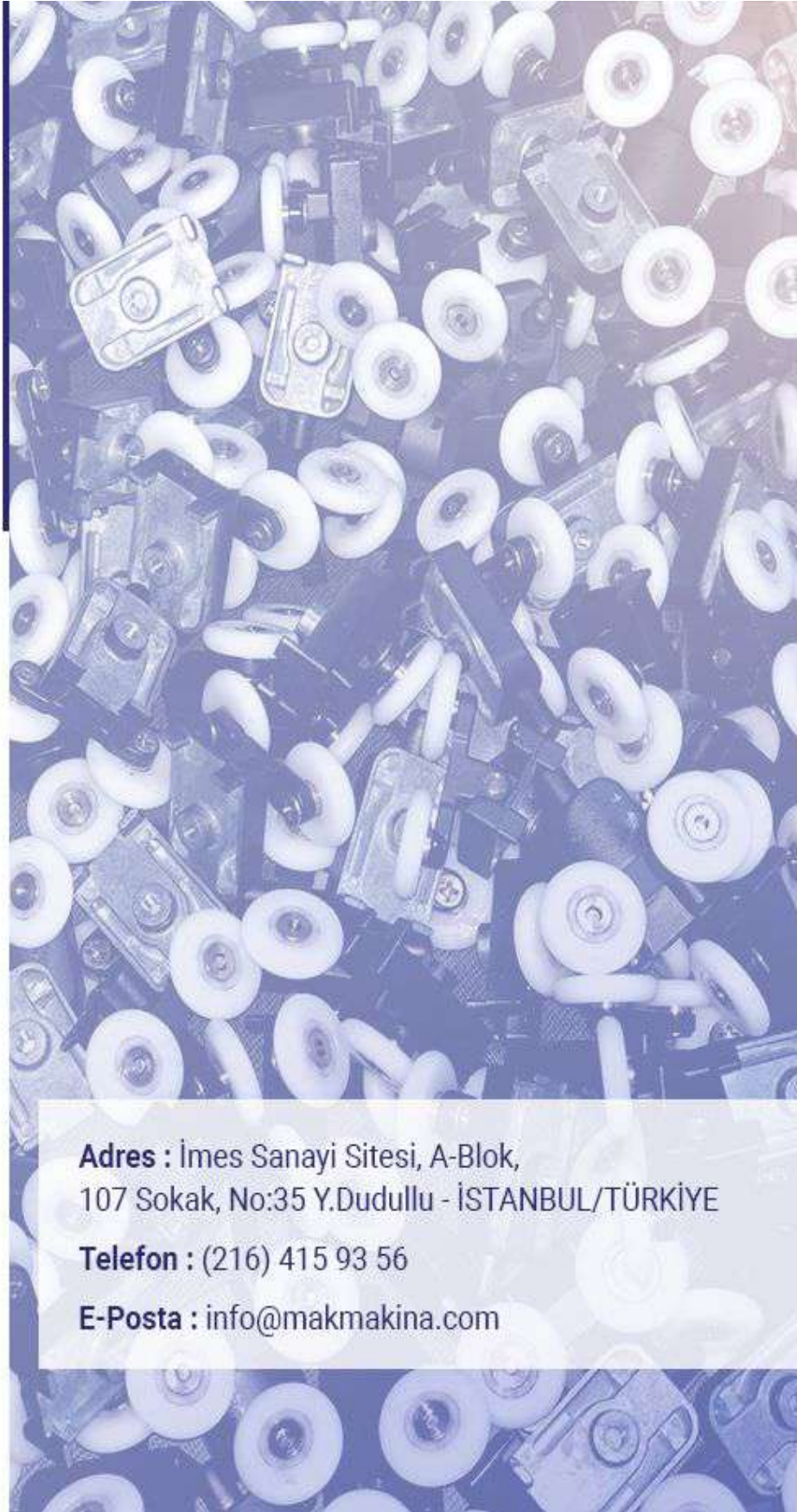

Adres : İmes Sanayi Sitesi, A-Blok,
107 Sokak, No:35 Y.Dudullu - İSTANBUL/TÜRKİYE

Telefon : (216) 415 93 56

E-Posta : info@makmakina.com